

Key-Locking Internal Locking

REVISIONS		DATE	APPROVED
ZONE	REV.	DESCRIPTION	

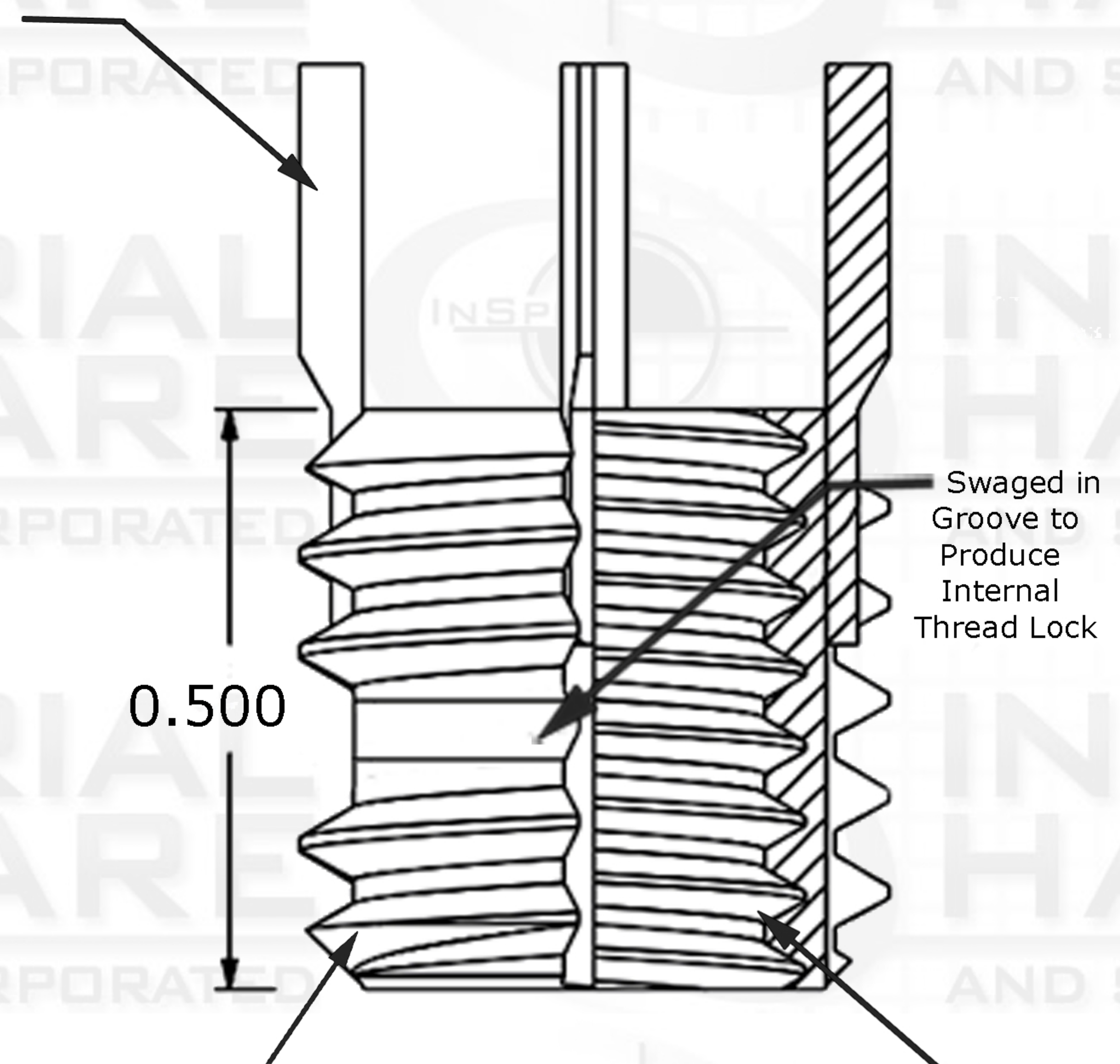

Key



Suggested Drill Bit Size



0.5782 (37/64)

External Thread Pitch
5/8-11

Internal Thread Pitch
3/8-16

PROPRIETARY AND CONFIDENTIAL

THIS DRAWING AND IT'S CONTENT IS THE SOLE PROPERTY OF INDUSTRIAL HARDWARE & SPECIALTIES,INC.. ANY REPRODUCTION IN PART OR AS A WHOLE WITHOUT THE WRITTEN PERMISSION OF INDUSTRIAL HARDWARE & SPECIALTIES,INC. IS STRICTLY PROHIBITED.

		Internal		NAME	DATE
		TH. STANDARD : ANSI/ASME		DRAWN	
		ACRONYM: UNC		CHECKED	
		ROTATION: Right-Hand		ENG APPR.	
		External		MFG APPR.	
		TH. STANDARD : ANSI/ASME		Q.A.	
		ACRONYM: UNC			
		ROTATION: Right-Hand			
		MATERIAL FINISH			
		Alloy Steel Type 4140		COMMENTS:	
NEXT ASSY	USED ON	PART NUMBER			
		35L8C-3808-37-05			
APPLICATION		DO NOT SCALE DRAWING			



**17-B KENTUCKY AVENUE
PATERSON, NEW JERSEY 07503
TEL: 973-684-4010 FAX: 973-684-3095
email: TechSupport@industrialhardware.com
www.industrialhardware.com**

SIZE	DWG. NO.	REV.
A		
SCALE:1:8	WEIGHT:	SHEET 1 OF 1