

Key-Locking Non-Locking

REVISIONS		DATE	APPROVED
ZONE	REV.	DESCRIPTION	

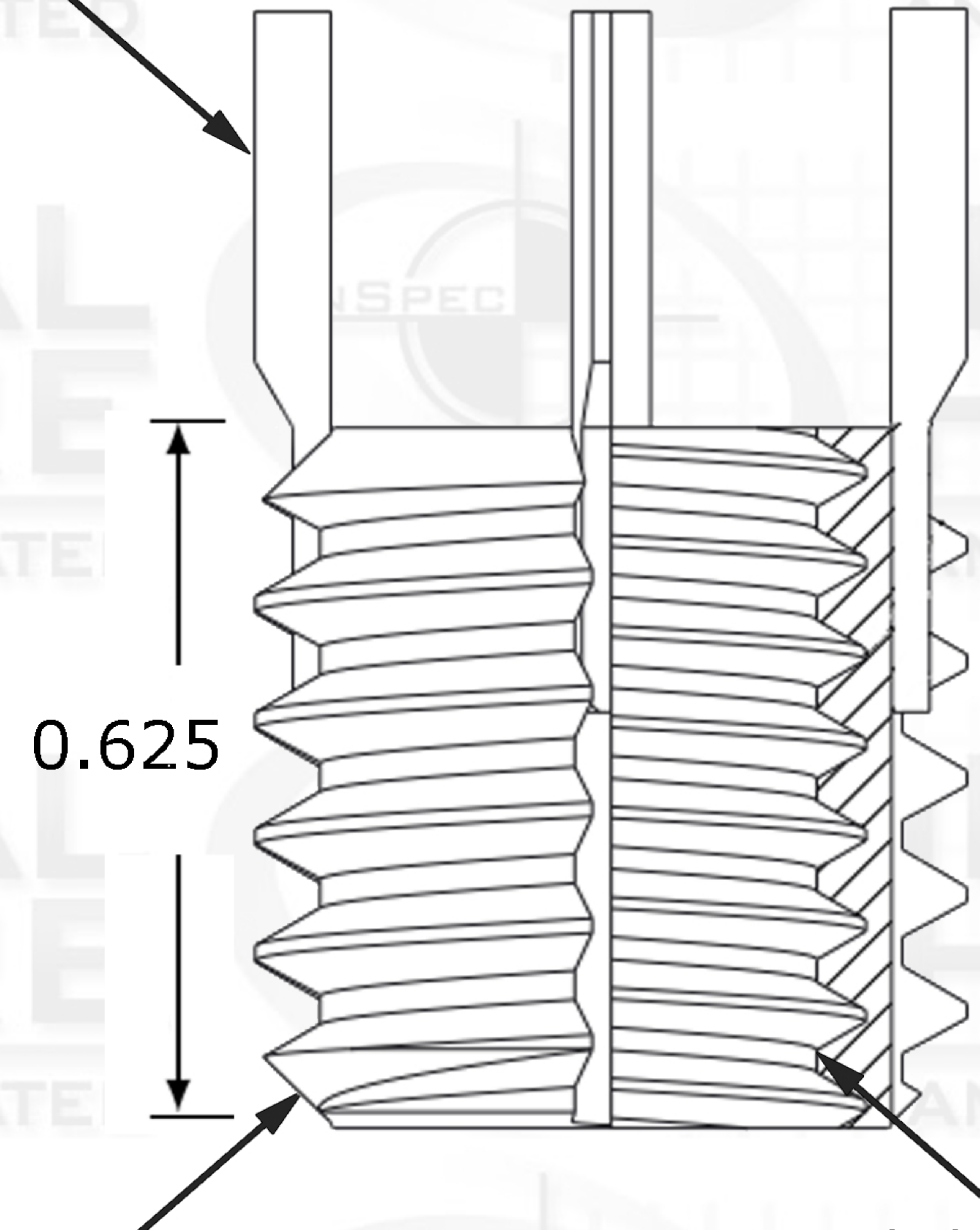

Key



0.625

External Thread Pitch
5/8-11

Internal Thread Pitch
1/2-20

Suggested Drill Bit Size



0.5782 (37/64)

PROPRIETARY AND CONFIDENTIAL

THIS DRAWING AND IT'S CONTENT IS THE SOLE PROPERTY OF INDUSTRIAL HARDWARE & SPECIALTIES,INC.. ANY REPRODUCTION IN PART OR AS A WHOLE WITHOUT THE WRITTEN PERMISSION OF INDUSTRIAL HARDWARE & SPECIALTIES,INC. IS STRICTLY PROHIBITED.

		Internal	NAME	DATE
		TH. STANDARD: ANSI/ASME	DRAWN	
		ACRONYM: UNF	CHECKED	
		ROTATION: Right-Hand	ENG APPR.	
		External	MFG APPR.	
		TH. STANDARD: ANSI/ASME	Q.A.	
		ACRONYM: UNC		
		ROTATION: Right-Hand		
		MATERIAL FINISH	COMMENTS:	
		Alloy Steel Type 4140		
NEXT ASSY	USED ON	PART NUMBER		
		35L8C-34KE-50-05		
APPLICATION		DO NOT SCALE DRAWING		



17-B KENTUCKY AVENUE
PATERSON, NEW JERSEY 07503
TEL: 973-684-4010 FAX: 973-684-3095
email: TechSupport@industrialhardware.com
www.industrialhardware.com

SIZE	DWG. NO.	REV.
A		
SCALE:1:8	WEIGHT:	SHEET 1 OF 1