

# MISC. HARDWARE

## ENDCAP FOR 13/16" CHANNEL

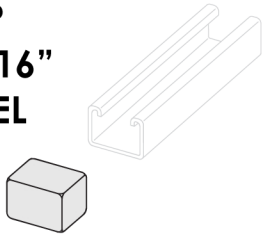

PART #	COLOR	CTN. QTY.	WGT./ 100
4882R	RED	50	2.8
4882W	WHITE	50	2.8
4882Y	YELLOW	50	2.8
4882GY	GREY	50	2.8

## ENDCAP FOR 1-5/8" CHANNEL

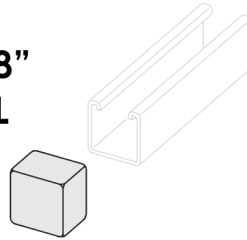

PART #	COLOR	CTN. QTY.	WGT./ 100
4881R	RED	50	4.2
4881W	WHITE	50	4.2
4881Y	YELLOW	50	4.2
4881GY	GREY	50	4.2

## ENDCAP FOR 3-1/4" CHANNEL

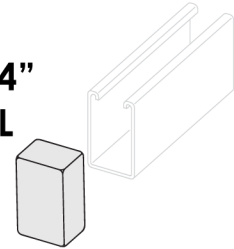

PART #	COLOR	CTN. QTY.	WGT./ 100
4880R	RED	50	7.3
4880W	WHITE	50	7.3
4880Y	YELLOW	50	7.3
4880GY	GREY	50	7.3

## RACEWAY ENDCAP FOR 13/16" CHANNEL

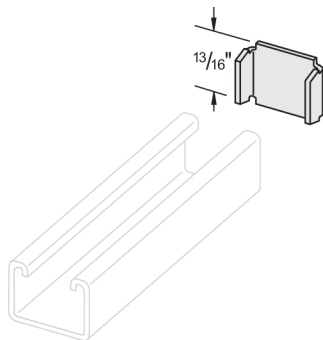

**4890**

100/CTN  
4 LBS/100

## RACEWAY ENDCAP FOR 1-3/8" CHANNEL

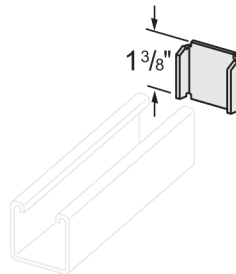

**4891**

100/CTN  
6 LBS/100

## RACEWAY ENDCAP FOR 1-5/8" CHANNEL

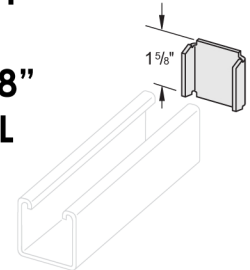

PART #	CHANNEL	CTN. QTY.	WGT./ 100
4892	12 GA,	100	10
4893	14 GA,	100	8

## RACEWAY ENDCAP FOR 3-1/4" CHANNEL

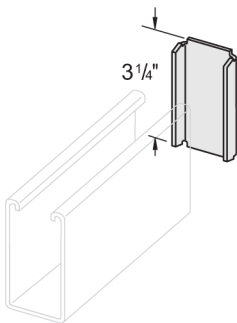

**4894**

100/CTN  
16 LBS/100

## OPEN SAFETY END CAP

ADD COLOR CODE AFTER PART #  
(GY)GREY, (R)RED, (W)WHITE, (Y)YELLOW

**4883**

FOR USE WITH  
3-1/4" CHANNEL



50/CTN  
5.6 LBS/100

**4884**

FOR USE WITH  
1-5/8" CHANNEL



50/CTN  
4.1 LBS/100

**4885**

FOR USE WITH  
13/16" CHANNEL

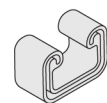

50/CTN  
3.5 LBS/100

STANDARD FINISH - EG, FOR METAL ENDCAPS